

Reduction of Zr (IV) in (KCl/NaCl) eutectic (50/50 mol %) containing KF/ZrCl₄ in molar ratios of 6/1 or 4/1 at 750° C. Characterization of the dissolved species by IR spectroscopy

F. BASILE, E. CHASSAING, G. LORTHIOIR

Centre d'Etudes de Chimie Métallurgique, 15 rue Georges Urbain, 94400 Vitry-sur-Seine, France

Received 15 June 1983; revised 14 October 1983 and 9 January 1984

Infrared analysis of baths which are mixtures of (KCl/NaCl) (50/50) with KF and ZrCl₄ in the molar ratio 4 or 6, indicates that the species present at 750° C are ZrF₄ and K₃ZrF₇. Voltammetric study of these melts containing 1 wt % Zr shows that ZrF₄ reduces in three steps: ZrF₄ → ZrF₂, ZrF₄ → Zr, ZrF₂ → Zr, whilst K₃ZrF₇ is reduced via: K₃ZrF₇ → Zr or K₃ZrF₇ → ZrF₂, ZrF₂ → Zr. It appears that ZrF₄ vanishes completely by increasing the KF/ZrCl₄ ratio until the KF concentration is able to stabilize K₃ZrF₇ in the melt.

1. Introduction

The aim of this work has been to investigate the experimental conditions for preparing massive and adherent deposits of zirconium through the electroreduction in molten baths of the tetrachloride, ZrCl₄, which is the raw material in this process. The melts likely to be used industrially have to be cheap. Thus, they are mainly made up of NaCl or mixtures of NaCl/KCl or KCl/LiCl. This latter bath is used if a lower temperature is desired. When added to the melt, ZrCl₄ is stabilized by chlorocomplex formation or, when an alkali fluoride is introduced, by fluorocomplex formation.

In this work we determine the nature of the species present at 750° C in melts of given compositions, and we examine the conditions for their stability. Through an understanding of these dissolved species, we are able to interpret the current-voltage curves.

2. Experimental methods

2.1. Electrochemical study

2.1.1. Description of the electrolysis cell. A cell in Hastelloy C (Fig. 1) contained a graphite

crucible. The Pyrex cover had several apertures for the insertion of:

the working electrode: several kinds of electrodes were used. With rods of Fe, Ni and W ($\phi = 3$ mm) the range of potentials between their dissolution and the deposition of the alkali metals can be explored. With tungsten, reproducible results were obtained, and this electrode was preferred. A more positive potential range can be explored with a glassy carbon electrode.

the auxiliary electrode, which was a graphite rod of spectroscopic purity ($\phi = 10$ mm) placed in a porous alumina compartment; this allowed the gas to exit from the cell.

the reference electrode. The choice of a reference electrode is a major problem in the electrochemistry of ionic liquids especially when they contain fluorides [1]. Our electrode was made of a silver wire immersed in the alkali chlorides constituting the electrolysis bath, with 1 mol % AgCl. It was inserted in a tube made of mullite (aluminosilicate) which possesses good corrosion resistance in fluoride baths. In the following, all the potentials are referred to the system Cl⁻/Cl₂.

a thermocouple protected by a silica sheath which was not permanently immersed in the melt.

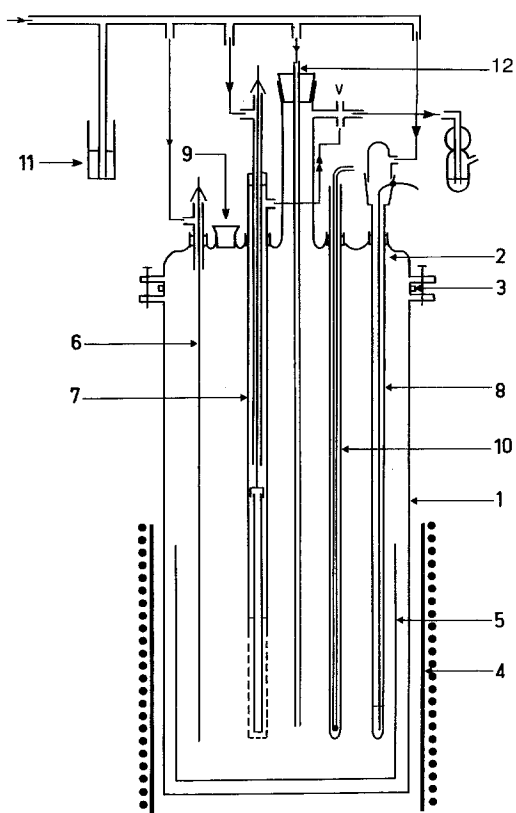

Fig. 1. Diagram of the experimental cell. 1. Cell in Hastelloy C; 2. Cover with six apertures; 3. Joint; 4. Furnace; 5. Crucible; 6. Working electrode; 7. Auxiliary electrode; 8. Reference electrode: Ag/AgCl; 9. Inlet for introduction of $ZrCl_4$; 10. Thermocouple; 11. Manometer; 12. Bubbling tube; \rightarrow argon circulation; \dashrightarrow Cl_2 evacuation; V vacuum pump.

a nickel tube by means of which argon bubbling served to accelerate the dissolution of the pellets of $ZrCl_4$ used as solute in the bath. When dissolution was achieved, the nickel tube was withdrawn.

2.1.2. Bath compositions. It was observed that a bath which contains free KF is very corrosive to industrial cells. For this reason, we tried to complex all of the KF introduced. As the nature of the complex formed was unknown, we first assumed that it was K_2ZrF_6 and used a mixture of KF/ $ZrCl_4$ in a ratio of 6. For comparison we also tested a mixture where the ratio was 4; in this case ZrF_4 and a fluorocomplex may be formed.

The baths studied had the following compositions:

(a) KCl/NaCl (50/50 mol %) with a mixture of KF/ $ZrCl_4$ in the molar ratio 6.

(b) KCl/NaCl (50/50 mol %) with a mixture of KF/ $ZrCl_4$ in the molar ratio 4.

In both cases the amount of zirconium was 1 wt %.

2.1.3. Procedure. The alkali chlorides and fluorides for use in the baths were dried separately at $400^\circ C$ under vacuum in a pyrex tube for 3 h. They were kept in a plastic box inside a metallic glove box under an argon atmosphere. A mixture KCl/NaCl/KF in convenient proportions was introduced to the cell which was maintained for 3 h at $400^\circ C$ under vacuum. Complete dehydration of salts and of the cell was obtained by raising the temperature to $750^\circ C$ under vacuum.

No bath treatment by HCl gas for the elimination of traces of hydroxides was carried out, because of possible effects of the gas on the metallic cell and the nickel electrode supports.

Nevertheless, as the salts were 99.5% pure we supposed that their contamination by hydroxides was very weak. On separation from oxychlorides by sublimation, $ZrCl_4$ was also kept in the glove box, inside of which a balance and a hand press allowed the preparation of pellets ($\phi = 10$ mm) with known weight. These pellets, introduced to the cell by an aperture in the cover, were only very weakly hydrolysed during their air exposure.

For the electrochemical studies we used a Tacussel PRT 20-10X potentiostat driven by a function generator. The scanning speed was $200 mV s^{-1}$.

2.2. Analysis

2.2.1. Potentiostatically obtained deposit: X-ray diffraction. The cathodic deposit obtained at a given potential consisted of a zirconium compound mixed with the melt. The melt could be eliminated with water only in the case of a zirconium deposit. The X-ray identification of Zr was then possible. On account of their hydrolysable character the other Zr compounds could not be washed and no X-ray spectra have been obtained with them.

2.2.2. Analysis of the melts. For this study the samples were molten and were contained in quartz ampoules, sealed under vacuum; they were held at

Table 1. Infrared active vibrations in the (900–200 cm⁻¹) frequency range of some zirconium compounds in the solid state

Compound	Peak position (cm ⁻¹)	References
– (ZrCl ₆) ²⁻ in Cs ₂ ZrCl ₆ (K ₂ ZrCl ₆ is isostructural with Cs ₂ ZrCl ₆)	326(s), 313(s)	Bronswyk <i>et al.</i> [4]
– Cs ₂ ZrCl ₆	630(w), 560(w), 466(w), 361(w)	Bronswyk <i>et al.</i> [4]
ZrF ₄	620(m, br), 460(s, br), 250(s, v. br) 550(br), {320, 295, 255} (m, br)	Goldstein <i>et al.</i> [5] Smith <i>et al.</i> [6]
K ₂ ZrF ₆	{485, 453} (s, br), 400(m), {330, 295, 245} (m, br)	Smith <i>et al.</i> [6]
(NH ₄) ₃ ZrF ₇ (isostructural with K ₃ ZrF ₇)	885, 520(br), {497, 444} (s, br) 380(w), {290, 270} (s, br)	Smith <i>et al.</i> [6]

s: stark; m: medium; w: weak; br: broad; v. br.: very broad

750° C for 24 h, then quenched in water. This fusion can be achieved in a silica tube without corrosion, confirming that the fluoride aggressiveness is less when combined in a complex than when in the form of free F⁻ ions. The baths were the same as those used, for the electrolysis studies but the amount of Zr varied from 1 to 7 wt %. The aim was to elucidate the effect, on the nature of the species present in the baths, of the value of the molar ratio F/Zr for a given amount of Zr and of the amount of Zr for a given molar ratio F/Zr.

2.2.2.1. X-ray diffraction. Apart from the melt spectrum, no X-ray diffraction has been obtained from the species because they were too dilute in the molten bath.

2.2.2.2. IR spectroscopy. The sample was finely ground in an agate mortar and mixed with dehydrated nujol. The mixture was pressed between two faces of CsI. In every case an IR spectrum was obtained. By comparing the spectra of the various complexes with those of the baths it was possible to determine the nature of the complexes present in them.

3. Literature data for the compounds of the KF/ZrF₄ and the KCl/ZrF₄ diagrams

The phase diagrams of KF/ZrF₄ indicates that the compound K₃ZrF₇ is stable from room temperature up to 900° C [2]. However, K₂ZrF₆ may also be found although it should not be stable beyond 750° C. Incidentally as

the baths contain large quantities of alkali chlorides formation of K₂ZrCl₆ must also be considered. Crystallographic data for ZrF₄, K₂ZrCl₆, K₃ZrF₇ and K₂ZrF₆ were listed by Wyckoff [3]. The site of the atoms in the lattice and the nature and the symmetry of the internal groups are sometimes not well defined. It is thus difficult to correlate the theoretically IR-active vibrations with the experimentally observed ones. The experimental results obtained by various authors are summarized in Table 1.

4. IR spectroscopic investigation of the melts

As the samples were quenched in water from 750° C they are representative of the liquid state. Indeed, when a melt (KCl/NaCl) containing K₂ZrCl₆ is quenched, its IR spectra is the same as that of pure K₂ZrCl₆ in the solid state (Fig. 2). Therefore, from the ionic state where K₂ZrCl₆ is dissolved in the melt, quenching reforms the solid compound.

Consequently the spectra of quenched samples may be compared to those of the pure solid compounds ZrF₄, K₃ZrF₇, K₂ZrCl₆, K₂ZrF₆ (Fig. 3). The vibrational frequencies of the spectra of Fig. 3 are in good agreement with the values given in the literature (see Table 1). Figs. 4 and 5 show spectra recorded at liquid nitrogen temperature, of melts whose compositions are indicated in Table 2. Comparison of these spectra with those of Fig. 3, indicates the presence in the baths of only two species, ZrF₄ and K₃ZrF₇.

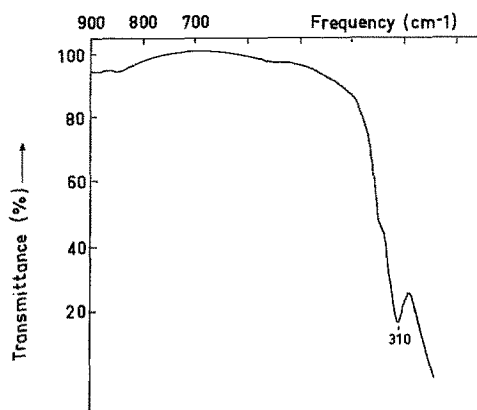
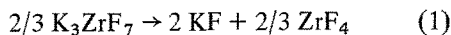

Fig. 2. Infrared spectrum of K_2ZrCl_6 in the KCl/NaCl (50/50 mol%) eutectic.

In the solid state these compounds are stable at $750^\circ C$. As it is stable to room temperature, ZrF_4 in solution in a molten bath is not susceptible to decomposition during quenching. But in the same conditions K_3ZrF_7 is able to decompose thus:



As will be seen in Section 6, the decomposition of K_3ZrF_7 dissolved in a melt is very slow com-

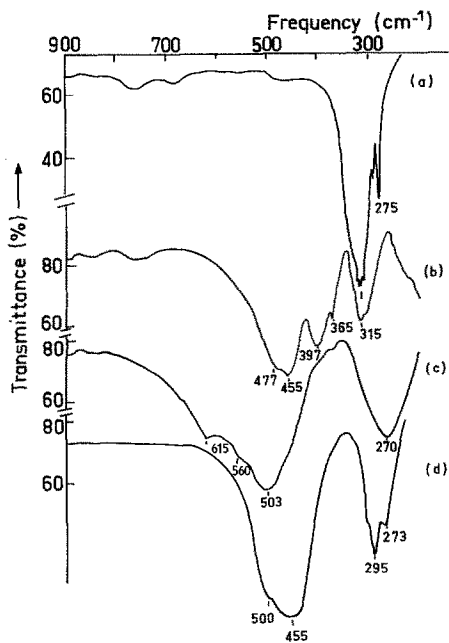

Fig. 3. Infrared spectra of: (a) K_2ZrCl_6 ; (b) K_2ZrF_6 ; (c) ZrF_4 ; (d) K_3ZrF_7 .

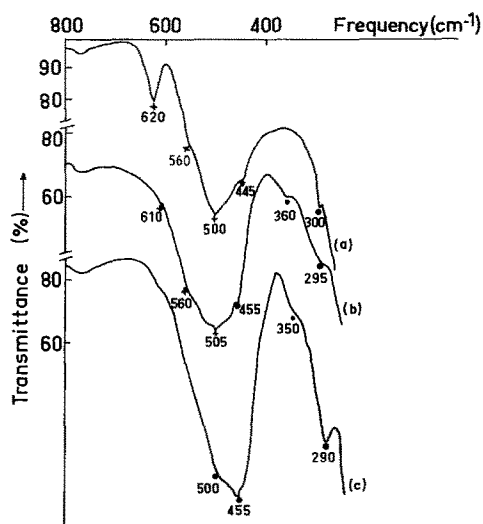

Fig. 4. Infrared spectra recorded at $-174^\circ C$ for bath with composition KCl/NaCl (50/50) + $KF/ZrCl_4 = 6$. (a) 1 wt % Zr; (b) 5 wt % Zr; (c) 7 wt % Zr. + - ZrF_4 ● - K_3ZrF_7 .

pared to the quenching rate of the samples, since Bath 4 containing initially 1 wt % Zr still contains 0.35 wt % Zr after 24 h. It can be concluded that decomposition during quenching of compounds stable at $750^\circ C$ is very unlikely.

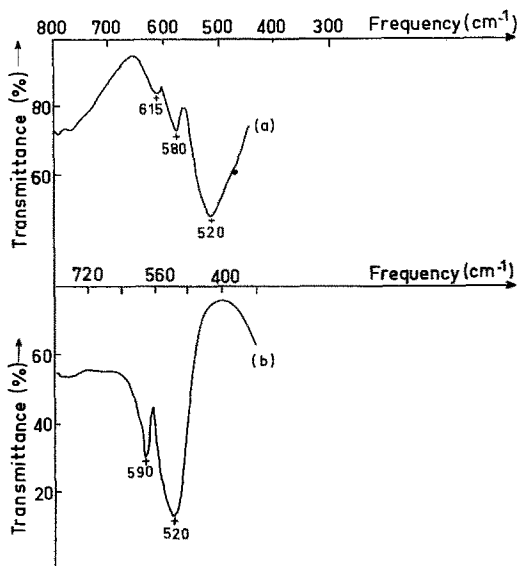

Fig. 5. Infrared spectra recorded at $-173^\circ C$ for baths with composition KCl/NaCl (50/50) + $KF/ZrCl_4 = 4$. (a) 1 wt % Zr; (b) 7 wt % Zr. + - ZrF_4 ; ● - K_3ZrF_7 .

Table 2. Composition of the baths

Number of bath	Eutectic composition	Molar ratio $KF/ZrCl_4$	Zr (wt %)	Species present in the bath
1	KCl/NaCl (50/50 mol %)	6/1	1	$ZrF_4 + K_3ZrF_7$
2	KCl/NaCl (50/50 mol %)	6/1	5	$ZrF_4 + K_3ZrF_7$
3	KCl/NaCl (50/50 mol %)	6/1	7	$ZrF_4 + K_3ZrF_7$
4	KCl/NaCl (50/50 mol %)	4/1	1	$ZrF_4 + \text{some } K_3ZrF_7$
5	KCl/NaCl (50/50 mol %)	4/1	7	ZrF_4

Table 2 indicates the presence in the baths of ZrF_4 and K_3ZrF_7 . The relative amounts of these compounds depend on the molar ratio $KF/ZrCl_4$ and for the same molar ratio on the $ZrCl_4$ concentration.

5. Voltammetric study of baths of numbers 1 and 4

5.1. Experimental results

IR spectroscopy provides information on the nature of the compounds in which Zr is involved. In Bath 1, ZrF_4 and K_3ZrF_7 are both present in large amounts. In Bath 4 mainly ZrF_4 is found but there is probably also K_3ZrF_7 .

The current-voltage curves for Bath 1 are

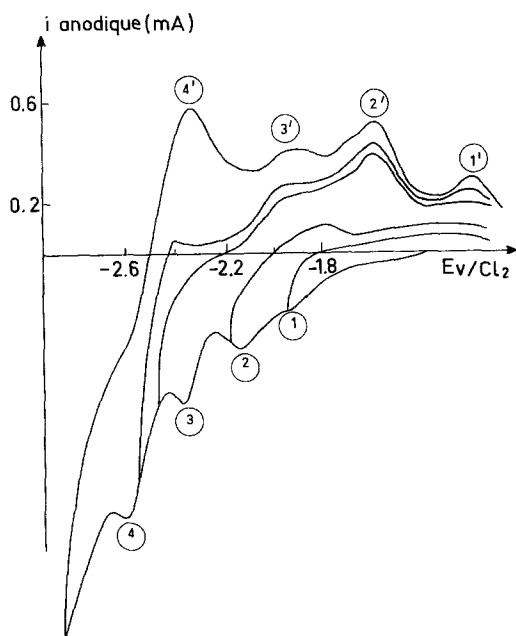

Fig. 6. Current-voltage curves for the reduction of Zr(IV) in the bath KCl/NaCl (50/50) + $KF/ZrCl_4 = 6$ (1 wt % Zr) at $750^\circ C$ (with a tungsten working electrode).

shown on Fig. 6 (working electrode: tungsten) and on Fig. 7 (working electrode: glassy carbon), and for Bath 4 on Fig. 8 (working electrode: tungsten).

Comparison of the voltammograms obtained with Baths 1 and 4 (Figs. 6 and 8) shows that the same oxidation and reduction waves are found at the same potentials. These figures also established the connection between the cathodic peak potential E_P^C and the anodic one E_P^A of a transition (oxidation + $e \rightleftharpoons$ reduction). The experimental values vs the chlorine electrode are collected in Table 3.

As the two species which are reduced, i.e. ZrF_4 and K_3ZrF_7 , are not in the same proportion in the two baths (see Table 2), the relative current intensities of the four reduction waves

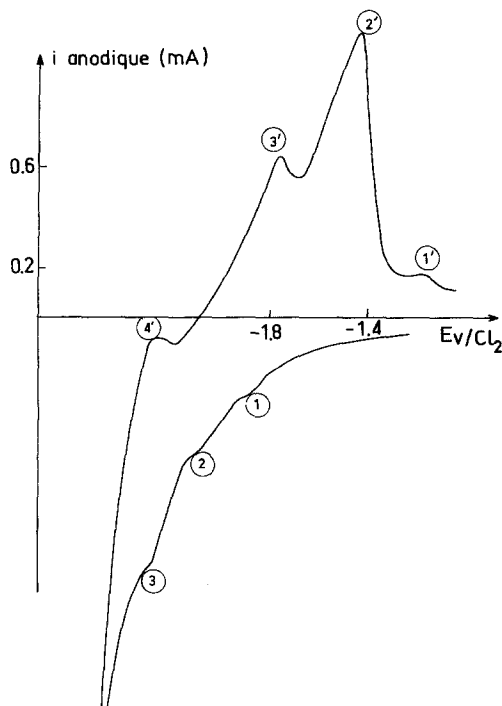

Fig. 7. Current-voltage curve for the reduction of Zr(IV) in the bath KCl/NaCl (50/50) + $KF/ZrCl_4 = 6$ (1 wt % Zr) at $750^\circ C$ (with a glassy carbon working electrode).

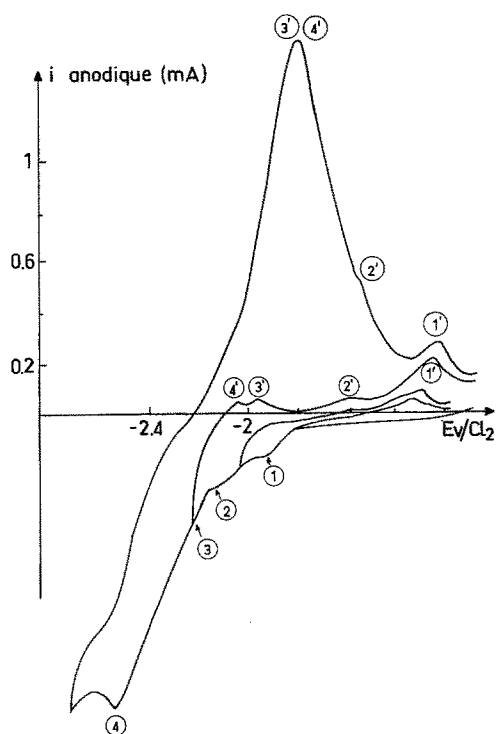

Fig. 8. Current-voltage curves for the reduction of Zr(IV) in the bath KCl/NaCl (50/50) + KF/ZrCl₄ = 4 (1 wt % Zr) at 750° C (with a tungsten working electrode).

for Bath 1 (see Fig. 6) are different from those of Bath 4 (see Fig. 8). For the bath rich in ZrF₄ (Fig. 8), a very significant reduction wave includes the 3rd and 4th transitions. The same behaviour is observed during the reoxidation.

In contrast, for the bath containing less ZrF₄ (Figs. 6, 7) four distinct waves appear separately during the reduction and the oxidation scans. When a vitreous carbon electrode is used as working electrode the oxidation wave 2' is very prominent with respect to the others.

5.2. Nature of the observed reduction steps

The likely reductions are those of ZrF₄ and K₃ZrF₇.

Table 3. Cathodic and anodic peak potentials for the four reduction stages occurring in the baths studied

Wave No.	E_P^C V/Cl ₂	Wave No.	E_P^A V/Cl ₂
1	-1.9	1'	-1.2
2	-2.1	2'	-1.55
3	-2.36	3'	-1.8
4	-2.55	4'	-2.3

Table 4. Reduction potential vs Cl⁻/Cl₂

Couple	ZrF ₄ /ZrF ₂	ZrF ₄ /Zr	ZrF ₂ /Zr
$E^{1/2}$ (V/Cl ₂)	-2.3 V	-2.51 V	-2.71 V

5.2.1. Reduction of ZrF₄. The calculated reduction potentials are obtained by summing the electrochemical reactions in the different cases.

Taking the couple ZrF₂/Zr as an example:

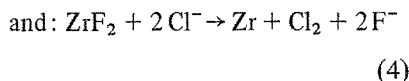
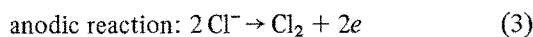
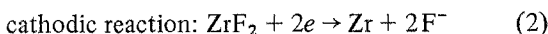

At 750° C using the values of the energy of formation ΔG for NaF and NaCl [7] the reduction potentials of Na⁺ with respect to the couples Cl⁻/Cl₂ and F⁻/F₂ were calculated. The difference between the oxidation potentials of Cl⁻ and F⁻ so obtained is 1.54 V.

This value added to the reduction potential calculated with respect to F⁻/F₂ for the ZrF₂/Zr couple gives its reduction potential vs Cl⁻/Cl₂. For the various couples the calculated values are given in Table 4.

Though approximate, these reduction potentials are similar to those observed (Table 3). The zirconium fluorides in the chloride bath reduce at potentials as positive as the chlorides in the same medium, and Table 4 indicates the order in which reductions occur.

5.2.2. Reduction of K₃ZrF₇. Two schemes are possible:



Comparison of the curves obtained for Baths 1 and 4 shows that the oxidation wave 2' is much weaker when the bath is rich in ZrF₄ (Fig. 8) than when it is rich in K₃ZrF₇ (Fig. 7). This wave is thus related to a re-oxidation into K₃ZrF₇. Otherwise the oxidation 1' is much more pronounced when the bath is rich in ZrF₄. Reduction 1 can be attributed to a reduction step of ZrF₄. The observed transitions have thus been indexed as follows:

Table 5. Transitions observed for different wave numbers

Wave No.	Transition
1	ZrF ₄ → ZrF ₂
2	K ₃ ZrF ₇ → Zr or ZrF ₂
3	ZrF ₄ → Zr
4	ZrF ₂ → Zr

A deposit obtained at a controlled potential of -2.4 V has the X-ray diffraction pattern of Zr, which confirms that the 3rd reduction leads to metallic Zr.

6. Remarks on the stability of the baths

Only Bath 4, which contained initially 1 wt % Zr has been studied for stability. During electrochemical investigation, samples of the bath were chemically analysed. The amount of Zr is recorded as a function of time in Fig. 9: the rapid loss of Zr indicates that the metal is not involved in a stable complex. In the case of Bath 1 it was also noticed qualitatively that an important loss of

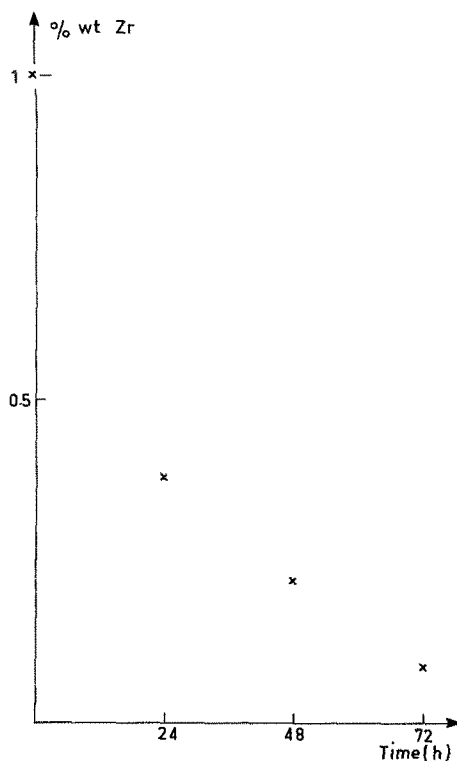

Fig. 9. Zr concentration as a function of time for the bath with initial composition KCl/NaCl (50/50) + KF/ZrCl₄ = 4 (1 wt % Zr).

Zr(IV) took place during that time. X-ray analysis of the zirconium compounds condensed at the top of the cell showed no crystallization, but it is probably ZrF₄ which has a sublimation point of 600°C.

7. Discussion

This study has been concerned with baths having compositions which are likely to have some interest for industrial purposes wherein zirconium is prepared by an electrolytic process. Various amounts of potassium fluoride were introduced into the baths in order to complex Zr⁴⁺. For Baths 1 and 4 the nature of the compounds present in solution has been determined by IR spectroscopy and their reduction steps established by a voltammetric study.

These baths include both ZrF₄ and K₃ZrF₇ and show considerable instability (T_s of ZrF₄ = 600°C). A comparison of these experimental results with the chemical equilibria in solution follows in order to infer what change in composition would improve the baths.

7.1. Bath 1 which contains 1 wt % Zr with a ratio KF/ZrCl₄ = 6

The amounts of KF and ZrCl₄ introduced correspond to the stoichiometric composition of K₂ZrF₆. However, IR spectroscopy shows that at 750°C, the melt does not contain K₂ZrF₆ but K₃ZrF₇ and ZrF₄. Indeed the reaction that occurs is:

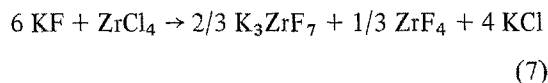

In addition we observed by IR spectroscopy that a bath fed with a mixture (KF/ZrCl₄) in the molar ratio 7 (1 wt % Zr) contains not only K₃KrF₇ but also ZrF₄. In this case ZrF₄ can only arise from the decomposition of K₃ZrF₇. Consequently the next reaction occurs:

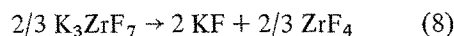

According to our experimental results K₃ZrF₇ stabilization can be obtained

(a) by increasing the Zr concentration while the ratio KF/KrCl₄ maintains the value 6. The

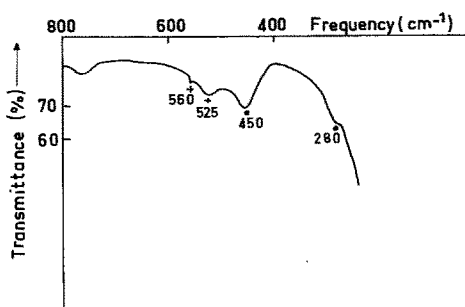

Fig. 10. Infrared spectra for K_3ZrF_7 in the bath $KCl/NaCl$ (50/50) (1 wt % Zr) at $750^\circ C$.

ZrF_4 quantity (Reaction 7) increases as the Zr concentration is increased, and when it is sufficient, Equilibrium 8 is completely shifted to the left hand side. Then the bath contains the K_3ZrF_7 and ZrF_4 species in the ratio corresponding to Reaction 7.

Fig. 4 which represents the IR spectrum of baths with increasing concentration in Zr shows a correlation with the increase of the ratio K_3ZrF_7/ZrF_4 . In stabilized baths the Zr concentration is high enough (around 7 wt %) but they do not contain free KF.

(b) by increasing the value of the ratio $KF/ZrCl_4$ in proportions corresponding to the composition of K_3ZrF_7 that is:



and for 1 wt % Zr. The partial decomposition of K_3ZrF_7 according to Equilibrium 8 is always observed and ZrF_4 appeared (Fig. 10). Stabilization of K_3ZrF_7 may be achieved with a convenient addition of KF, and when it is, the electrolytic reduction of Zr(IV) present in the bath occurs as follows:

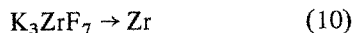

or

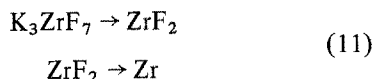

Such an electrolytic bath has the disadvantage of containing KF which is very corrosive for the metallic cells employed in industry. If, with a ratio $KF/ZrCl_4 = 7$ one permits the Zr concentration to be more than 1 wt % the Zr effect will add to those of KF to shift Equilibrium 8

to the left hand side and the necessary quantity of Zr will be smaller than in the case of an initial ratio of 6.

7.2. Bath 4 with $KF/ZrCl_4 = 4$ (1 wt % Zr)

IR spectroscopy indicates that K_3ZrF_7 and ZrF_4 are present in this bath. In similarity to the situation described above, the reactions that occur are:

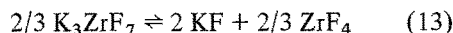
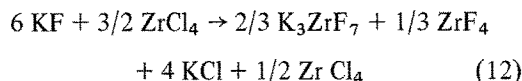

The KF that appears in Equilibrium 13 reacts with $ZrCl_4$ from Reaction 12 again giving the compounds of the right hand side of Equation 12.

Equilibrium 13 is shifted to the right hand side whatever the initial amounts of KF and $ZrCl_4$. The IR spectrum (Fig. 4) shows that, owing to the instability of K_3ZrF_7 , the baths contain principally ZrF_4 .

8. Conclusion

IR spectroscopy allowed identification of the species dissolved in the baths studied. Thus, we could explain the four reduction steps that appear on the voltammograms obtained at $750^\circ C$. Three of these correspond to the reduction of ZrF_4 according to the scheme $ZrF_4 \rightarrow ZrF_2$, $ZrF_4 \rightarrow Zr$, $ZrF_2 \rightarrow Zr$ and the last one to the reduction of K_3ZrF_7 to ZrF_2 or Zr.

Analysing the experimental results we concluded that partial decomposition of K_3ZrF_7 occurs in both baths.

The initial composition of Bath 4 excludes the free KF but does not allow stabilization of the K_3ZrF_7 .

In the case of Bath 1, the K_3ZrF_7 instability can be corrected by increasing the KF or Zr concentration. It seems that a bath free of KF containing 7 KF for 1 $ZrCl_4$, with a Zr concentration adequate to stabilize K_3ZrF_7 , could be used for the electrolytic extraction of zirconium metal. This investigation may contribute to a better understanding of the experimental conditions which improve the electrowinning of zirconium in molten baths.

The initial composition of Bath 4 excludes the free KF but does not allow stabilization of the K_3ZrF_7 .

In the case of Bath 1, the K_3ZrF_7 instability can be corrected by increasing the KF or Zr concentration. It seems that a bath free of KF containing 7 KF or 1 $ZrCl_4$, with a Zr concentration adequate to stabilize K_3ZrF_7 , could be used for the electrolytic extraction of zirconium metal. This investigation may contribute to a better understanding of the experimental conditions which improve the electrowinning of zirconium in molten baths.

References

- [1] R. Winand, *Electrochim. Acta* 17 (1972) 251.
- [2] A. V. Novoselova, Yu. M. Korenev, Yu. P. Simanov, *Dokl. Akad. Nauk. SSSR* 139 (1961) 893.
- [3] R. W. G. Wyckoff, 'Crystal Structures', 2 edn (Interscience Publishers, New York, 1967).
- [4] W. van Bronswyk, R. J. H. Clark and L. Maresca, *Inorg. Chem.* 8 (1969) 1397.
- [5] M. Goldstein, R. J. Hugues and W. D. Unsworth, *Spectrochim. Acta* 31A (1975) 621.
- [6] P. W. Smith, R. Stoessiger and A. G. Turnbull, *Inorg. Phys. Theor. J. Chem. Soc.* AX (1968) 3014.
- [7] I. Barin and O. Knacke, 'Thermochemical Properties of Inorganic Substances' (Springer Verlag, Berlin, Heidelberg, New York, 1973).